

X6100, an ultra-portable short-wave transceiver that adopts high-performing SDR software radio platform architecture, powerful baseband and RF units, transmitting and receiving separated dual-channel structure and 24bit sampling and large dynamic RF front-end unit, can obtain extremely high radio transmitting and receiving indicators.





















The whole device integrates rich and varied operation functions and desktop-like functions, such as recording call, variable bandwidth digital filter, digital noise reduction and so on, which brings you a new cognition and experience on amateur radio. With its compact structure and appearance, you can immediately set forth on a journey with it, get close to nature, and enjoy the fun of outdoor communication.

- HF/50MHZ full mode (supporting data communication)
- Transmitting power: external power supply: 10W, battery: 5W
- 4-cun high-resolution color screen (800\*480)
- Built-in large capacity lithium battery pack (3000mAh, 12V)
- Built-in efficient automatic antenna tuner
- Integrated standing wave scanner and voice pager
- Integrated modem, preset message, CW automatic call
- Built-in Bluetooth/WLAN function, which can realize wireless audio, keyboard and mouse operation
- Integrated USB line control/transmission, supporting USBHOST.
- Standard high-stability TCX0 internal clock source

We strongly recommend you to read through this Manual to rapidly keep abreast of the operation & control method of the X6100 before using it.

- To carry out effective transmission, it is necessary to obtain the corresponding amateur radio operation qualification and apply for the station setup license.
- Transmission activities shall not be carried out in non-amateur frequency bands.

## Safety Precautions

-  Do not use this device in lightning weather. *Disconnect the power supply and antenna in advance.*
-  Do not touch the antenna during the transmission of the device.
-  Do not apply AC power to the DC interface on the side panel of transceiver. Otherwise it may cause fire or damages to the device.
-  Do not apply more than 15VDC voltage to the DC interface on the side panel of transceiver. Otherwise it may cause fire or damages to the device.
-  Do not reverse the polarity of the power cable. Otherwise it may cause fire or damages to the device.
-  Do not operate or touch the device with wet hands. Otherwise it may cause electric shock or damages to the device.
-  In case of smoke or peculiar smell, cut off the power supply immediately, remove the power cable, and then contact the supplier.
-  Do not use the device in areas, vehicles or aircraft where it is prohibited.
-  Do not use this device while driving or operating engineering equipment.
-  Do not use the device in petrol stations, gas stations or the place with combustible gas around.
-  Do not use the device in hospitals or in an environment where people wear medical devices.
-  Do not expose the device to rain, snow or any liquid. Otherwise it may cause damages to the device.
-  Do not use headphones at high volume.
-  Do not disassemble or modify the device.
-  Do not place the device near the heat source or in direct sunlight.
-  Do not place the device in a dusty or damp place.
-  Do not place the device in a poorly ventilated place and do not block any radiator on the device. Otherwise, the device may be damaged due to overheating.
-  Do not wipe the device with organic solvents, such as benzene or alcohol. This may damage the surface of the equipment.
-  Do not apply impact force on the device. Otherwise it may cause fire or damages to the device.
-  Do not place the device in the area with temperature range beyond  $-10^{\circ}\text{C}\sim+55^{\circ}\text{C}$ .
-  Cut off the power supply and remove the external power cable if the device is not used for a long time.

## Battery Precautions

This device contains lithium-ion battery components, so improper use may result in dangers such as smoke, fire or battery rupture.

- The battery pack is installed inside the backplane of the equipment. Do not hit the backplane of the device.
- Do not place the device in a place where the temperature is higher than 60°C; otherwise, the battery pack may rupture or catch fire.
- Do not place the back of the device near heat sources, such as stove fire or direct sunlight.
- Do not weld, disassemble or modify battery components by your won. This can lead to protection failure and battery damage, which can further lead to fire and other hazards.
- In case of obvious deformation, seepage or peculiar smell at the installation place of the battery pack, the device shall not be further used, and distributor shall be contacted immediately for assistance.
- Do not use the device beyond its temperature range; otherwise, the service life of the device and battery pack may be reduced or damaged.
- Do not leave the battery pack in fully charged or fully discharged state for a long time. Otherwise, the service life of battery pack will be shortened. Please maintain the electric quantity of battery pack within 40%~50% if the device is to be left unused for a long time, and then keep it properly.
- The service life of the built-in battery pack is about 3~4 years generally. Please replace the battery pack once its service life reaches this period. Even if the battery still works, its performance will be significantly reduced and service time will be greatly shortened. The battery pack can be generally charged and discharged for 300~500 times. This depends on specific usage conditions.
- Do not charge the device with other non-compliant chargers.
- Pay attention to the condition of the device when charging. Stop charging immediately in case of any abnormality.
- Do not charge the device in vehicles under direct sunlight.

## Important Note

- Make sure you have had relevant operating certificates or permissions before making a call on the frequency band of amateur radio.
- Make sure the antenna feed system meets the transmitting requirements before actual transmitting.
- The device may be hot after continuous and long-term transmitting (such as FT8 operation). Please appropriately extend transmitting interval and strengthen external heat dissipation.
- Please place the device in a safe and reliable place and keep it away from children or unauthorized persons.

## Electromagnetic Interference

It shall be noted when using wireless LAN or Bluetooth devices that when other wireless devices, such as wireless mouse, wireless keyboard and wireless router, work in the same frequency band, they may interfere with each other, resulting in unstable or interrupted connection of the device. In such case, please keep away from other devices or stop using those devices.

# I. Panel Instructions

## Front panel

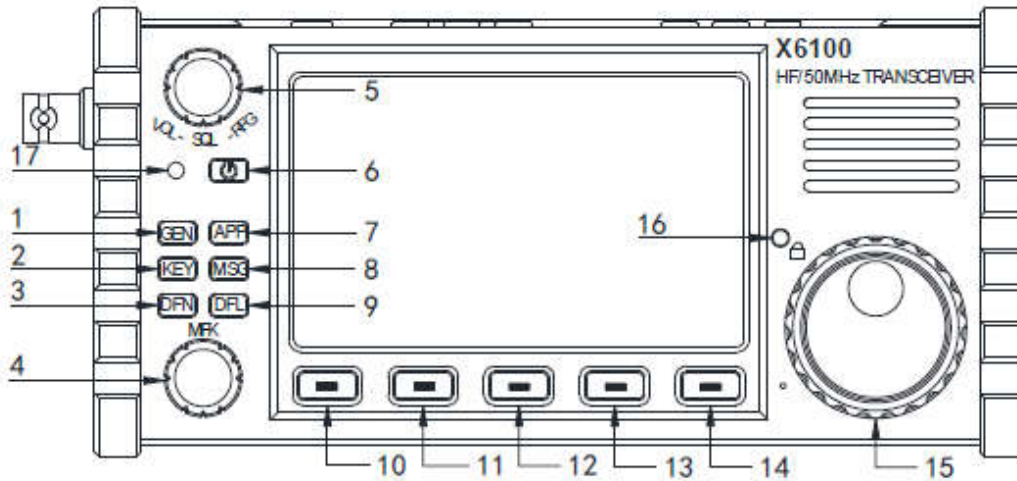

1 GEN button

Press it to bring up the general settings menu.

2 KEY button

Press it to bring up taper settings menu.

3 DFN button

Press it to bring up the menu of digital functions.

4 MFK multi-function knob

Default:

Customize:

5 VOL/SQL/RFG knob

Default: volume control.

Press the knob to adjust SQL muting depth.

Press the knob again to adjust RFG gain.

6 Power button

Press and hold it to turn on the power supply of transceiver.

Press and hold it for 1s to turn off the power supply of transceiver.

7 APP button

Press it to bring up function menu.

8 MSG button

Press it to bring up information editing and storage interface.

9 DFL button

Press it to bring up digital filter settings interface

10~14 Multi-function button

Press it to execute functions displayed on screen.

15 Main knob

Rotate it to adjust frequency.

16 Lock button

Long press for 1s to lock the keys operation on panel.

Long press for 1s again to unlock.

17 Power supply/TR indication

The indicator light is green after startup.

When the transceiver is in transmitting state, the indicator light is red.

### Left plate

18 ANT

BNC interface, 50Ω, for antenna connection.

19 I/Q OUT

IQ signal output port 3.5mm stereo socket.

20 DC IN

External power input port, 5525 type.

Note: input voltage shall not be higher than 15V DC.

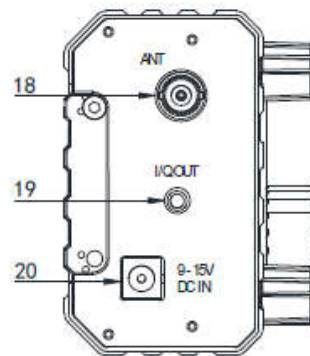

### Right plate

21 CARD

microSD memory card slot

22 DEV

USB port. Slave interface

23 HOST

USB port. Host interface.

24 S/P

External speaker/headphone interface, with speaker or headphone output can be set via menu. It is a 3.5mm stereo interface achieving stereo output.

Note: short circuit or silence will be caused if plugging the single track plug externally.

25 KEY

It is a 3.5mm stereo interface used to connect manual/auto tapper. See page 8 for connection.

26 ACC

It is a 3.5mm stereo interface. See page 8 for interface definitions.

27 MIC

Hand microphone interface. The interface is of type RJ45.

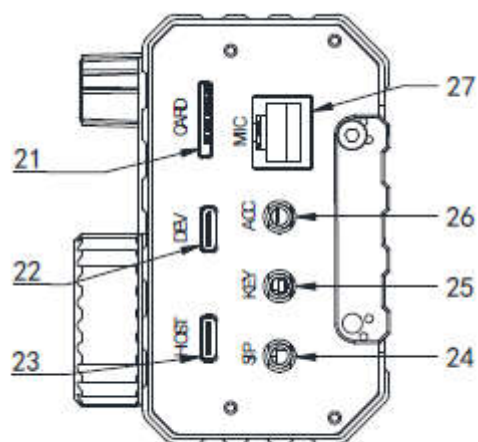

## Top button

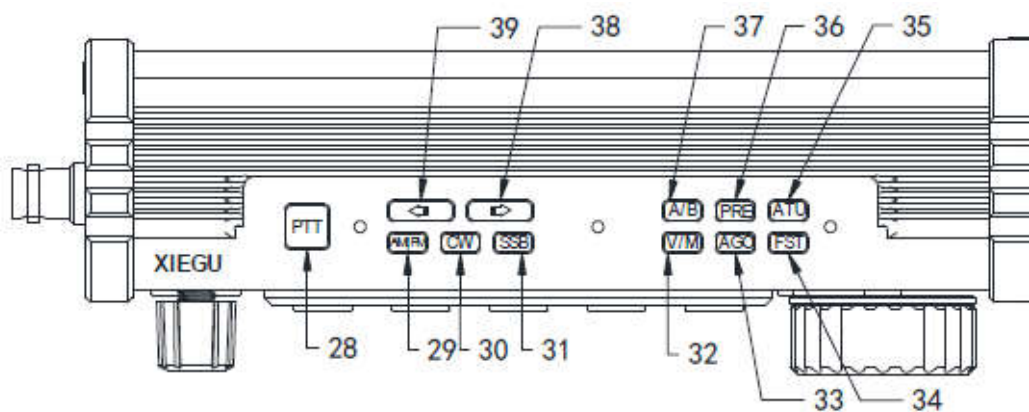

28 PTT

PTT button on device body.

29 AM|FM

AM/FM mode switch button.

30 CW

CW mode switch button

31 SSB

SSB mode switch button

32 V/M

VF0/MEM0 status switch

33 AGC

AGC switch/speed selection button

34 FST

Fast step selection button

35 ATU

Built-in antenna tuner access/tuning button

36 PRE

Pre-amplifier/pre-attenuator switch

37 A/B

VF0A-VF0B switch button

38~39 Left and right switch

Frequency band/channel increase and decrease switch

## Hand microphone button

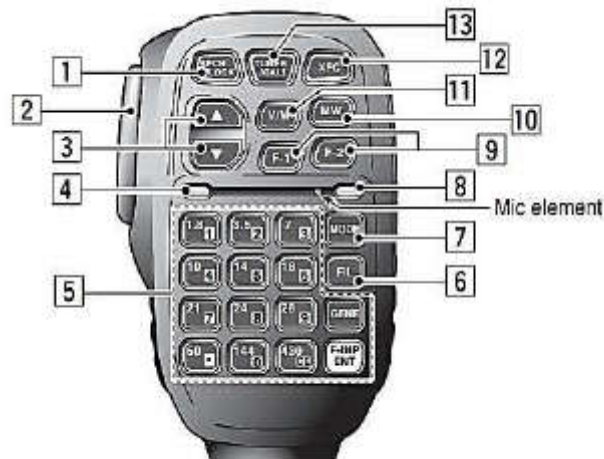

- |                                |  |
|--------------------------------|--|
| 1. LOCK button                 | Lock button  |
| 2. PTT button                  | Transmitting control button  |
| 3. Up/down menu 1)             | Frequency increase/decrease button (user-defined, detailed in system menu 1) |
| 4. Transceiver indicator light | Hand microphone operation indicator light                                    |
| 5. Figure button area          | Figure keyboard area   |
| 6. FIL button                  | Filter selection   |
| 7. MODE button                 | Selection of working mode of host  |
| 8. Functional indicator light  | <i>No</i>  |
| 9. Function button             | F1/F2 key (user-defined, detailed in system menu 2&3)                        |
| 10. MW button                  | Memory operation   |
| 11. V/M button                 | Frequency/channel switching  |
| 12. XFC button                 | <i>No function temporarily</i>   |
| 13. TUNER button               | Long press to start antenna automatic tuning                                 |

## Interface Definition

### Microphone port

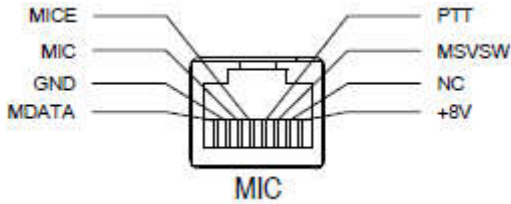

### Definition of ACC interface

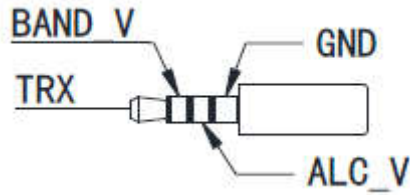

### Connection of S/P Port

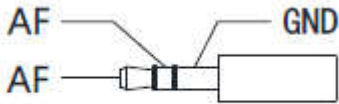

### Definition of I/Q OUT interface

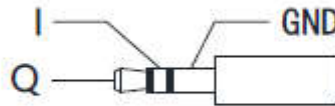

### Connection of KEY Port

Connect manual/automatic tapper according to the schematic diagram shown in the right figure.

### Note :

- If the connector of the manual tapper is a 6.5mm 2-core plug, please change it to a 3-core 3.5mm stereo plug according to the wiring method shown in the right figure, and connect the trigger end of the electric key to the "Di" or "Da" terminal.
- Take care that direct use of the 2-core to 3-core adapter or incorrect wiring may result the radio in CW transmission status all the time.

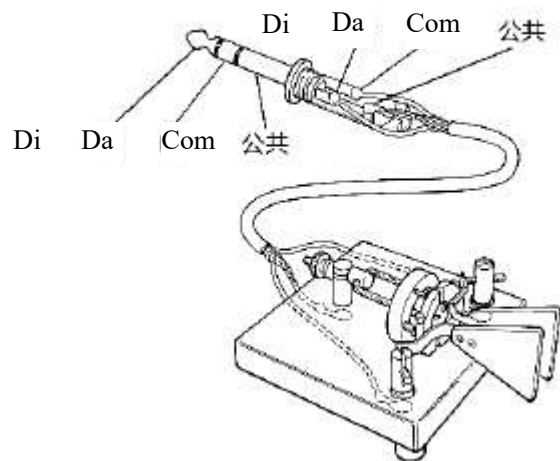

- Using plugs of other specifications may damage the socket.
- X6100 may switch to transmitting mode if plugging in or unplugging the tapper plug when it is working.
- Please cut off the power supply of X6100 before connecting or disconnecting the tapper.



## Power source wiring

13.8V external DC power supply can be used for X6100. The current load capacity of DC power supply shall be at least 3.5A. Attached power lines can be used to connect to radio and DC power supply.

DC power supply shall be connected in strict accordance with following figure to avoid reverse polarity connection.

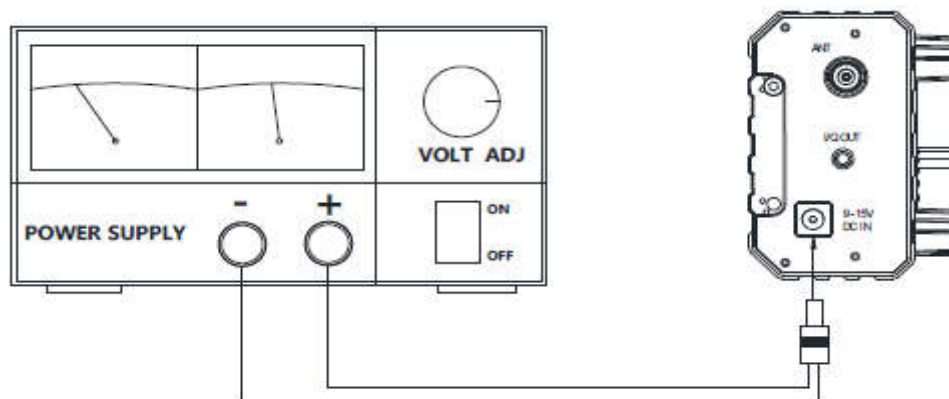

■ EMC magnet ring can be applied on power lines to prevent external disturbance from entering radio via power lines and radio-frequency interference in radio from radiating externally via power lines when external power supply is adopted for X6100. Magnet ring shall be installed at the side closing to radio to greatest extent.

## Charging

When the battery voltage is lower than 7.4V, X6100 will temporarily turn off the transmission function; when the battery voltage is lower than 7.2V, X6100 will be forced to turn off in order to protect the battery.

Please use the accompanying charging adapter to charge the X6100 transceiver. Insert the AC terminal of the charging adapter into the mains power supply and the output terminal into the DC interface on the left side of the X6100 to charge the internal battery (the charging switch should be turned on in the Menu 1 of General setting). It takes about 6 hours for fully charging, and the battery voltage is about 8.3V~8.4V. After charging, X6100 will automatically disconnect the internal charging circuit.

During shutdown and charging, the status indication of TR indicator is as follows:

- Green flashing: charging
- The green light is always on: the battery is full
- Red flashing: battery failure
- No light: charging turned off

## Note :

■ Polarity of power lines shall be carefully inspected to avoid reverse polarity connection when external power supply is adopted.

■ Reverse connection of power may cause severe damage to the radio.

■ Do not charge the radio with any other charger that does not meet the specifications. Otherwise, the device may be damaged

## Caution!

1. The charging adapter can only charge the X6100 and cannot be used for transmitting as there is a risk of damaging the device.

2. Under no circumstances shall the DC port on the left of the X6100 be connected to a voltage higher than 15VDC. Otherwise, serious device damage may occur.

## II. Screen Display Interface

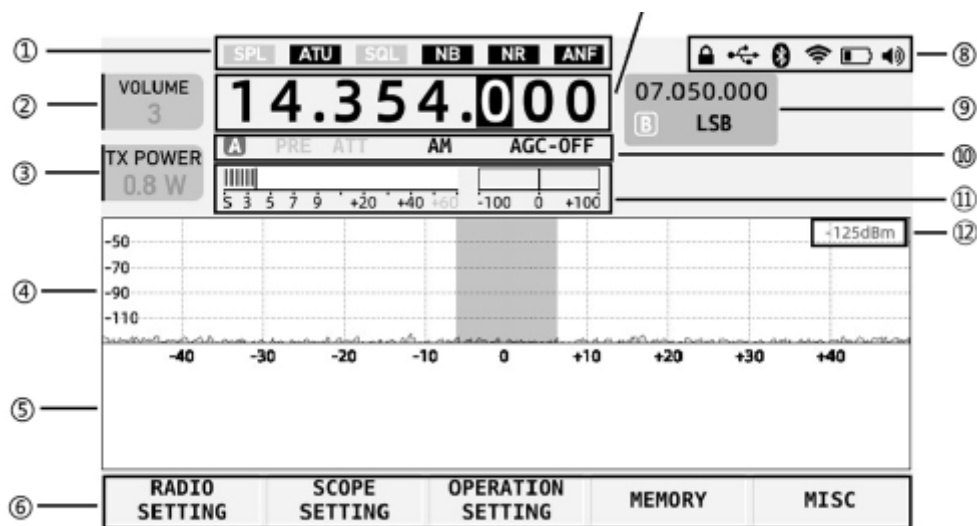

① Status display area 1

This area displays SPL, ATU, SQL, NB, NR and ANF switch status.

② Volume tag

Display volume/noise level/RF gain adjustment. Short press the volume knob to switch the above three status.

③ Multi-function tag

The figure shows the transmitting power adjustment tag. Items of the tag displayed can be rapidly set via menu.

④ Spectrum display area

It displays the signal strength of about -122dBm at minimum

⑤ Waterfall plot display area

⑥ Multi-function menu area

Short press the corresponding button at the bottom of the screen to operate corresponding functions.

⑦ Main VFO frequency display area

⑧ Status display area 2

This area displays the status including lock/USB port/Bluetooth/WLAN/battery/volume.

⑨ VFOB display area

⑩ Status display area 3

This area displays PRE/ATT/mode /AGC status

⑪ Table header area

This area displays S table and CW frequency aligned windows

⑫ Signal strength dBm display

⑬ Audio spectrum display area

## Basic Operation

### Turn on/off radio

1. Press the on-off button for 1s to turn on the radio.
2. Press the on-off button for 1s again to turn off the radio.



### Adjust audio volume

1. Turn the volume knob to the left or right to adjust the output volume.
2. Short press the volume knob to switch volume/muting depth/RF gain adjustment.



### Operating frequency band and mode selection

Follow the instructions below to select the amateur band and set mode.

- Frequencies beyond the amateur band can only be received while cannot be transmitted.

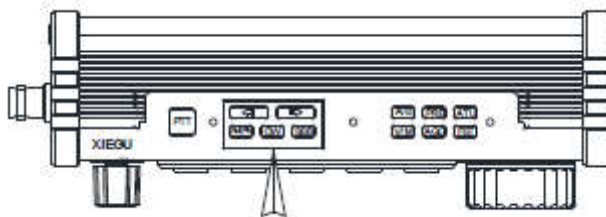

1. Press the corresponding mode button at the top of the radio to switch to corresponding mode.
2. Press left or right [←][→] button to orderly switch operation frequency band:  
1.8MHz◀-▶3.5MHz◀-▶7MHz◀-▶10MHz◀-▶14MHz◀-▶18MHz  
21MHz◀-▶24MHz◀-▶28MHz◀-▶50MHz
3. Figure buttons on hand microphone can be used to directly switch to corresponding wave band.

## Set operation frequency

1. Rotate large knob to set the frequency. Clockwise rotate the knob to increase the operating frequency and anticlockwise rotate the knob to decrease the operating frequency.
2. Press the top [FST] button to change the frequency adjustment bit for fast adjustment.

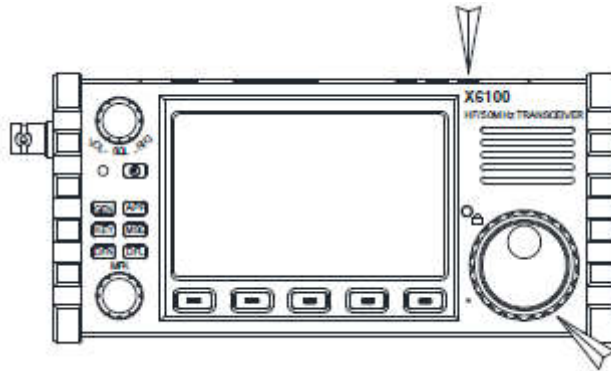

### 3. Set frequency by multi-function hand microphone

- Press [F-INP ENT] key on hand microphone, and the X6100 will be in frequency setting state, and cursor will be flickering at the first place on the left of frequency display bit;
- Input expected frequency values one by one, and press [F-INP ENT] key again to complete the frequency setting.

For example, press buttons in following sequence to set current frequency as 14.25000MHz:

1. Press [F-INP ENT] key firstly;
2. Press         number keys one by one;
3. Press [F-INP ENT] key again to complete the setting.

## Adjustment of RF gain and muting level

Proper RF gain can facilitate to improve the quality of signal received. In general, appropriately reducing the RF gain value at some low-frequency ranges with strong interference can significantly improve the hearing.

Adjustment methods of RF gain:

1. Short press the volume knob to bring up the RF GAIN setting items. The tag on the left side of the screen will display RF GAIN.
2. Rotate the volume knob to adjust the RF gain value.

### SQL setting

When muting is necessary for signals or noise less than a certain amplitudes, appropriate muting level can be set to disable the audio switch without signal so that the speaker can be muted.

Operation methods:

1. Short press the volume knob to bring up the RFGAIN setting items. The tag on the left side of the screen will display SQLLevel.
2. Rotate the volume knob to set the muting level. At the same time, the muting grade will display on the screen.

■ The muting grade gradually strengthens from S1 ~S9, corresponding to strength. For example, when the muting grade is set to be S3, it indicates that the speaker will sound when the signal strength is more than S3. Otherwise, the speaker will in the silent mode.

## Pre-amplifier/pre-attenuator

The pre-amplifier can improve the receiving effect of some weak signals of high frequency range and the sensitivity of the receiver.

Pre-attenuator can improve barrage jamming caused by strong signals and the performance of receiver.

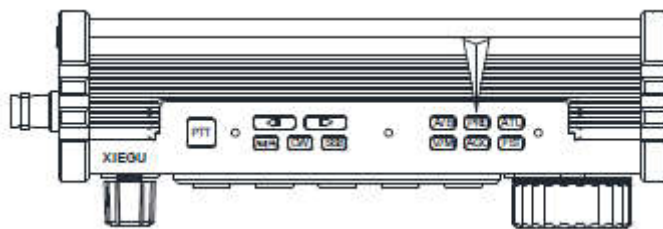

### Operation method:

1. Short press the [PRE] button at the top, and the character PRE appears at the top of the screen, indicating that the pre-amplifier has been turned on.
2. Short press [PRE] button again and the character ATT will appear on the top of the screen, indicating that the pre-attenuator has been turned on.
3. Short press [PRE] button again and no character will appear on the top of the screen, indicating that the current state is shoot-through state.

■ Before they are used in frequency range less than 14MHz, disabling the pre-amplifier is recommended so that the radio can be in the shoot-through state, which is conducive to strengthen the front-end performance of the receiver and reduce the influence of interference signals.

■ When the level displays that the received signals exceed  $-40\text{dBm}$ , turning on the pre-attenuator is recommended to avoid the decreasing of the dynamics of the receiver due to strong signals.

## Automatic gain control (AGC)

Select appropriate AGC control parameters in different work modes to achieve a good receiving effect.

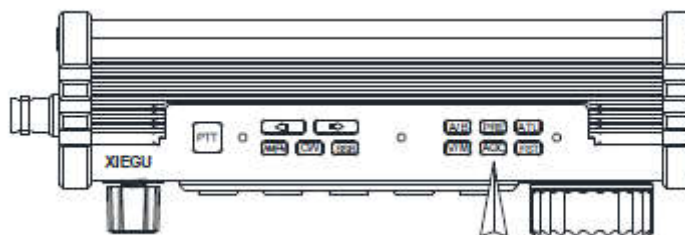

### Operation method:

1. Press [AGC] key at the bottom of the screen in a short time, enable/ disable or select different AGC modes and circulate them in the following order:

AGC-AUTO → AGC-OFF → AGC-SLOW → AGC-FAST

AGC-S: slow AGC control

AGC-F: fast AGC control

AGC-A: automatic AGC control

AGC--: AGC off

Recommended settings: AM mode: AGC-S

SSB/CW mode: AGC-F

2. When the AGC-A mode is selected, the radio will automatically select the appropriate AGC control parameter according to the current work mode.

■ It is recommended to turn on AGC, which will improve the performance of the receiver and will not affect the receiving sensitivity index.

## Transmitting (SSB/AM/FM mode)

1. Press the PTT button on the microphone to start transmitting. Please speak to the microphone in a normal voice.
2. During the transmitting, the TX indicator light on X6100 will turn red, as will the indicator light on hand microphone.
3. Release the PTT button to return to the receiving state.

## Transmitting (CW mode)

Use manual tapper or external keying unit to insert into the KEY port at the tail of the radio. (See page 5 for the definition of connection)

1. Insert keys into the KEY port;
  2. Press [CW] button on the top of radio to switch mode to CW (or CWR);
  3. Turn on QSK function in menu and set appropriate QSK time;
  4. Press the tapper to enable CW communication.
- Disable the QSK function in menu. There will be only CW sidetone of transceiver after pressing tapper under such conditions, but signals will not be transmitted externally.

## Automatic Antenna Tuner

There is an efficient ATU integrated inside the X6100 radio to help you quickly erect and debug antenna.

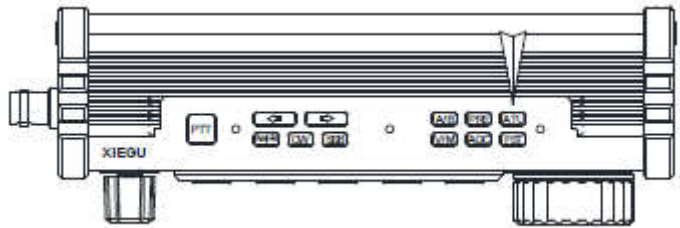

1. Short press [ATU] button to connect with built-in antenna tuner. There will be an antenna icon at the top of screen.
2. In the case that the antenna tuner is accessed, long press the [ATU] key for 1s to start ATU automatic tuning functions. It will automatically return to receiving state after the tuning.

Note :

1. Short press [ATU] key, and there will be an ATU icon at the top of screen, indicating that antenna tuning functions are enabled. The functions are only enabled but not working.
2. After the antenna tuner is tuned, the antenna tuner must remain to be open before the antenna tuner in the machine is used.
3. If "SWR" icon is displayed at the top of the screen and flashes once transmitting is enabled after the tuning, it indicates that standing-wave of current antenna is still large and tuning is required to be carried out again.
4. Antenna tuning shall be turned off once natural resonance of antenna reaches current frequency band.
5. When a whip antenna is used and the internal antenna tuning is started for tuning, strong radio frequency interference may be caused to the unit or electronic equipment.

## Use the build-in PTT of radio for transmitting

The X6100 radio integrates PTT button and build-in microphone, which make it convenient when using the radio outdoors.

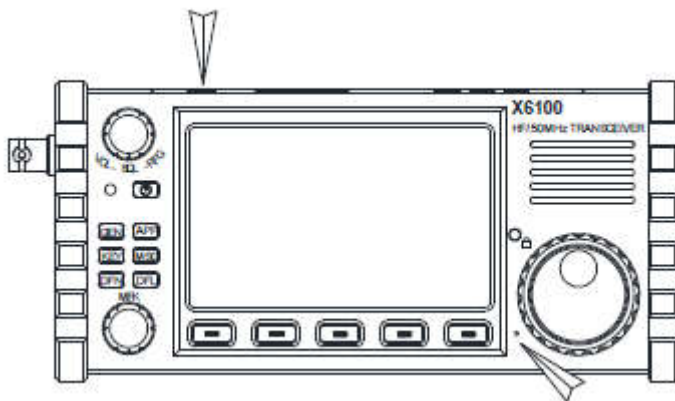

1. Press the PTT button on the top of the device and speak to the built-in microphone hole at the left of large knob to transmit voice.
2. Release the PTT button after transmitting to return to receiving status.

### Note :

■ Do not place the antenna very close to or near exposed parts of the body, especially the face or eyes, when transmitting in hands. It is required to get close to antenna, transmitting can be carried out at a low power.

## Lock main knob / screen backlight adjustment

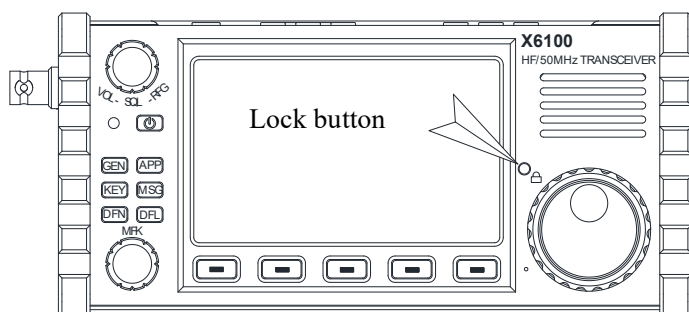

### Operation methods:

- 1、 Long press the lock button to lock the operation of the main knob, and the symbol of "Lock" will be displayed at the upper right of the screen.
- 2、 Short press this key in the unlocked state to adjust the brightness of the screen backlight step by step.

## Multifunctional operation

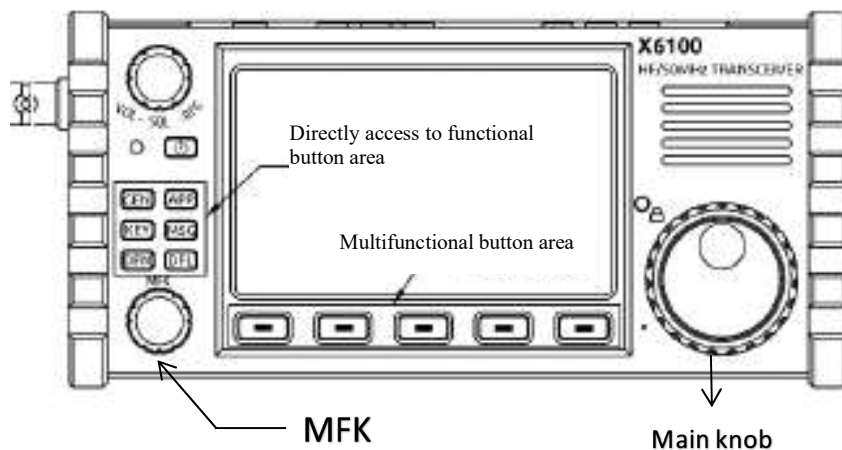

### Operation methods:

1. Function buttons in the left area of the panel can directly access the common function operation menu.
2. After selecting a direct button, the corresponding menu will appear at the bottom of the screen. Press the corresponding button below to operate the function.
3. After selecting a function, rotate the large knob or MFK multi-function knob to adjust the corresponding parameter value. The adjustment parameters are displayed in the numeric part of the Function menu tab.



## GEN function operation

After short pressing the [GEN] key, the Default menu will appear at the bottom of the screen, as shown in the following figure:

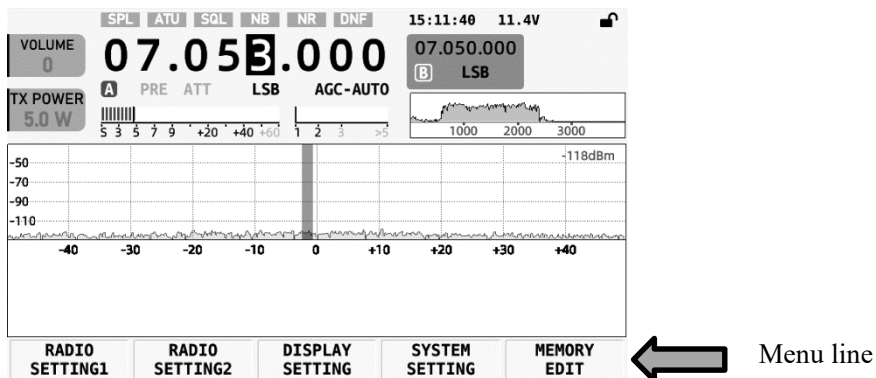

Short press the key corresponding to [RADIO SETTING 1] to enter the "General setting 1" submenu, as shown in the following figure:

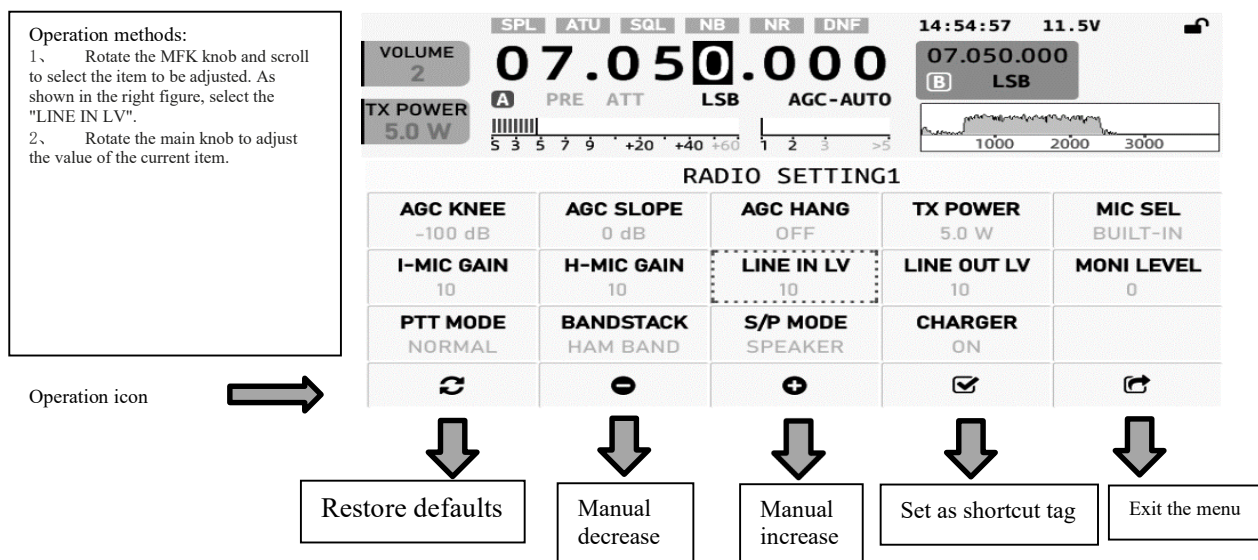

Menu functions are defined as follows:

AGC KENN	AGC SLOPE	AGC HANG	TX POWER	MIC SEL
AGC start control level	AGC control gradient	AGC hold	Transmitting power	Microphone selection (built-in microphone / hand microphone)
I-MIC GAIN	H-MIN GAIN	LINE IN LV	LINE OUT LV	MONI LEVEL
Built-in microphone gain	Hand microphone gain	Line input level	Line output level	Monitor level
PTT MODE	BANDSTACK	S/P MODE	CHARGER	-----
PTT mode	Band display mode	Headphone port output selection (headphone/external loudspeaker)	Charging switch	-----

Short press the key corresponding to [RADIO SETTING 2] to enter the "General setting 2" submenu, as shown in the following figure:

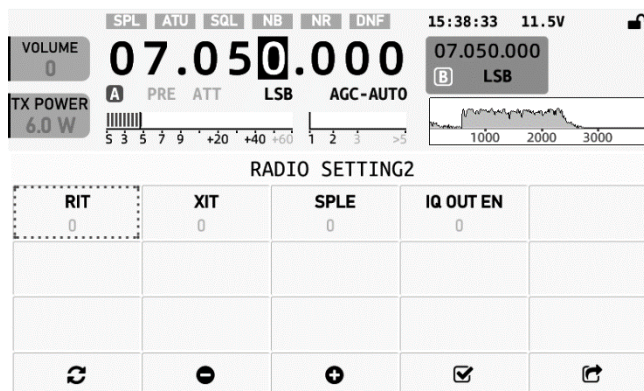

Menu functions are defined as follows:

RIT	XIT	SPL	IQ IUT EN	-----
Reception frequency tuning	Transmission frequency tuning	Split frequency operation switch	IQ output switch	-----

### DISPLAY SETTING Menu

Short press the key corresponding to [DISPLAY SETTING] to enter the "Display setting" submenu, as shown in the following figure:

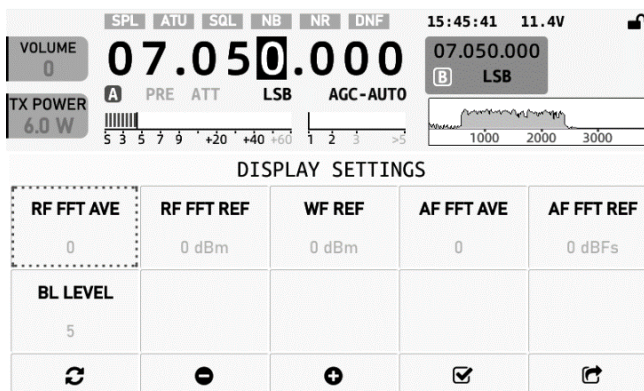

Menu functions are defined as follows:

RF FFT AVE	RF FFT REF	WF REF	AF FFT AVE	AF FFT REF
RF spectrum display average	RF spectrum display reference level	Waterfall reference offset level	Audio spectrum display average	Audio spectrum display reference level
BL LEVEL	---	---	---	---
Backlight brightness	---	---	---	---

## SYSTEM SETTING Menu

Short press the key corresponding to [SYSTEM SETTING] to enter the "System setting" submenu, as shown in the following figure:

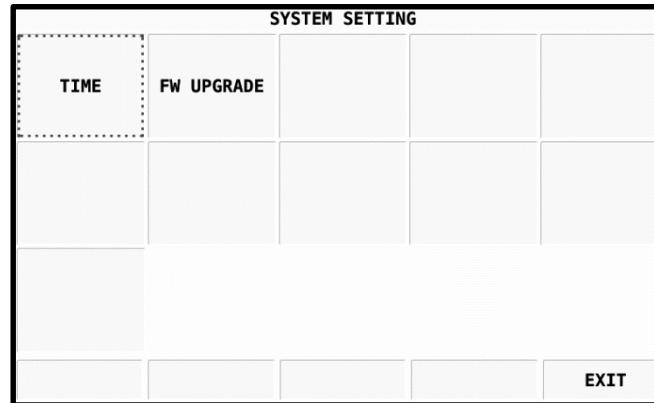

Menu functions are defined as follows:

TIME	FW UPGRADE	---	---	---
Time setting	Firmware update	---	---	---

## MEMORY SETTING Menu

Short press the key corresponding to [MEMORY SETTING] to enter the "Memory setting" submenu, as shown in the following figure:

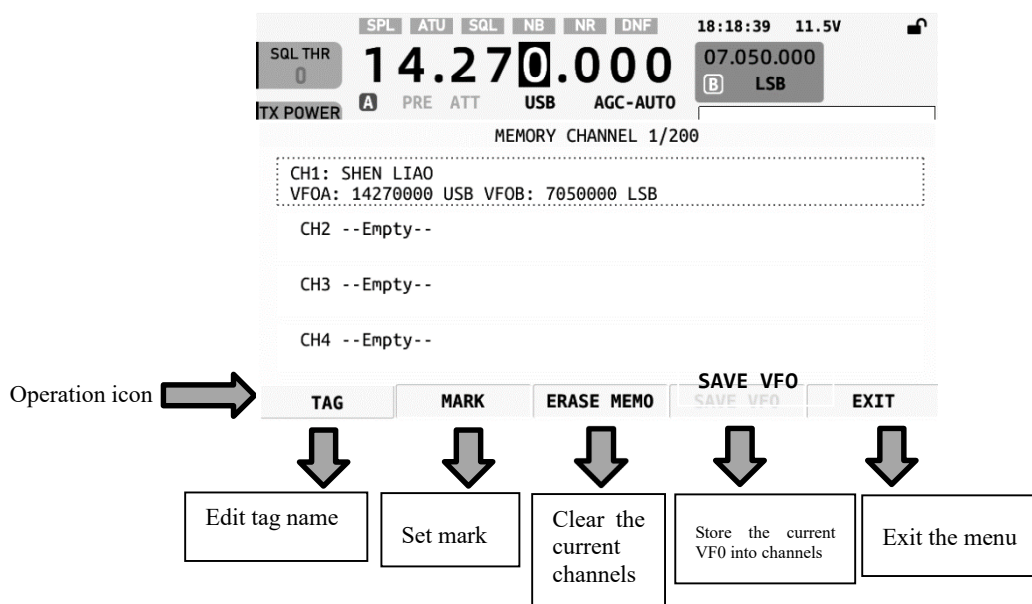

### Example of Memory Channel Operation:

The current frequency is VF0A: 14.270000/USB, VF0B: 7.050000/LSB

- 1、 Short press [SAVE VFO] to save the current frequency, mode, etc. into a blank channel.
- 2、 Short press [TAG] to name the current channel.
- 3、 Short press [MARK] to mark the current channel, and the symbol of a small house will be displayed on the channel tag.

### Example of Clearing Channel Operation:

- 1、 Turn the main knob to select the channel tag you want to clear.
- 2、 Short press [ERASE MEMO] to clear the channel information of the memory.

## APP function operation

Short press [APP] key to enter the sub-menu of the "Application", as shown in the figure below:

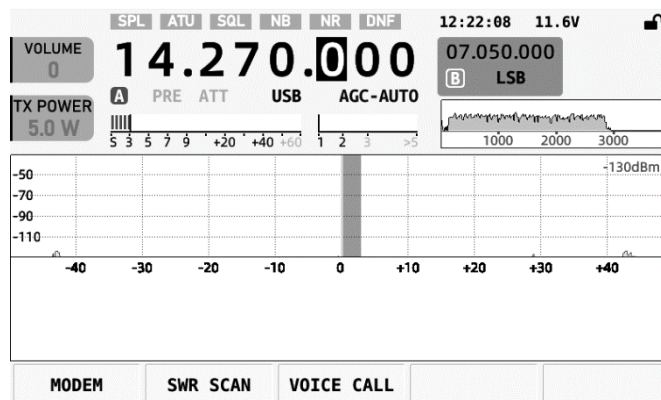

Menu functions are defined as follows:

MODEM	SWR SCAN	VOICE CALL	---	---
Enter the modem interface	Enter the standing-wave scanner interface	Recording call	---	---

## MODEM Menu

Short press the corresponding key of [MODEM] to enter the sub-menu of the "Modem", as shown in the figure below:

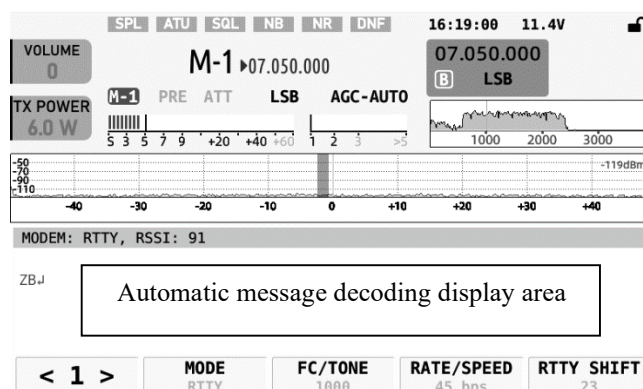

Sub-menu <1> Definitions are as follows:

<1>	MODE	FC/TONE	RATE/SPEED	RTTY SHIFT
	Select RTTY/CW/BPSK mode	Carrier / Side tone frequency	Baud rate / code rate	Offset

Sub-menu <2> Definitions are as follows:

<2>	AFC	SQL	CLEAR	EXIT
	Carrier tracking	Modem muting	Clear text	Exit

## Automatic Sending of Preset Information under MODEM

In the MODEM interface, short press the [MSG] key on the left side of the panel to enter the automatic message sending interface, as shown in the figure below:

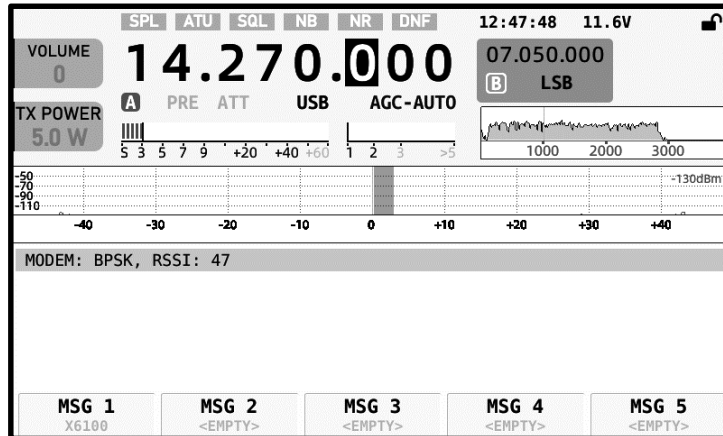

Operation methods:

- 1、 When a tag has pre-stored information, there is information preview under the tag. The above figure shows that: MSG1 tag already has pre-stored information; the tag has information preview, which is convenient for users to quickly find the required call tag.
- 2、 Press the corresponding tag, X6100 will start sending the preset text information in the tag in the mode selected by MODEM until the sending of information is completed.

## SWR SCAN Menu

The X6100 has the antenna standing-wave scanner, which can scan the standing-wave parameters of the current antenna to help users adjust the antenna.

Short press the corresponding key of [SWR SCAN] to enter the sub-menu of the "Standing-wave Scanner", as shown in the figure below:

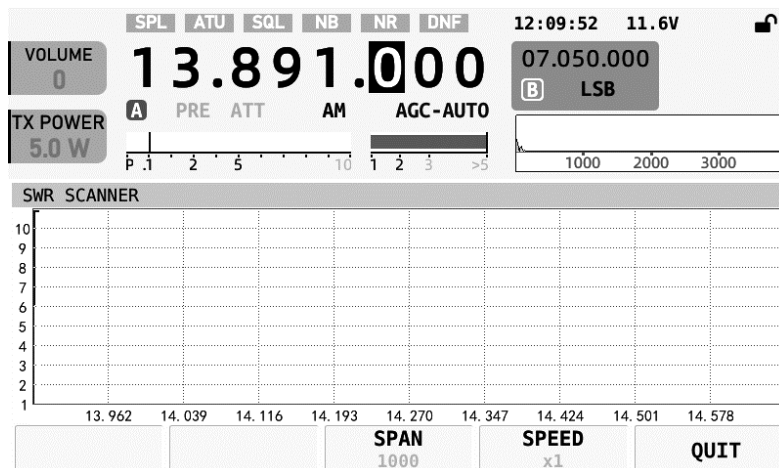

Menu functions are defined as follows:

---	---	SPAN	SPEED	QUIT
---	---	Scanning bandwidth	Scanning speed	Exit

SPAN: short press this key to change the scanning bandwidth.

SPEED: short press this key to change the scanning speed.

QUIT: exit the standing-wave scanner interface

## Automatic Call by Calling Preset Recording under Voice Mode

X6100 has a built-in recording caller, which can record and store the call voice in the machine in advance, and the stored voice can be used for call transmission.

Key sequence:

[APP] - [VOICE CALL], enter the recording call interface, as shown in the figure below:

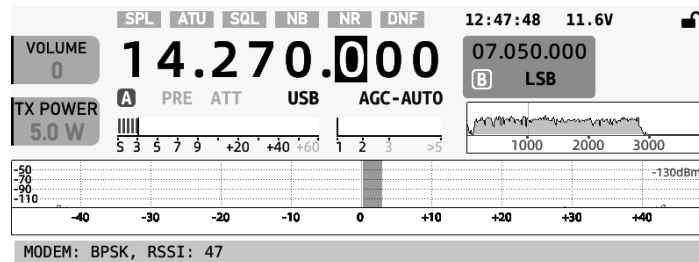

Operation methods:

1. When a tag has pre-stored information, there is a prompt under the tag to facilitate users to quickly find the required call tag.
2. Press the corresponding tag, X6100 will start sending the preset recording information in the tag until the sending of information is completed.

\*For the recording method of voice messages, see the relevant operation chapter of "MSG" key in later part.



## KEY function operation

Short press [KEY] to enter the menu of KEY items, as shown in the figure below:

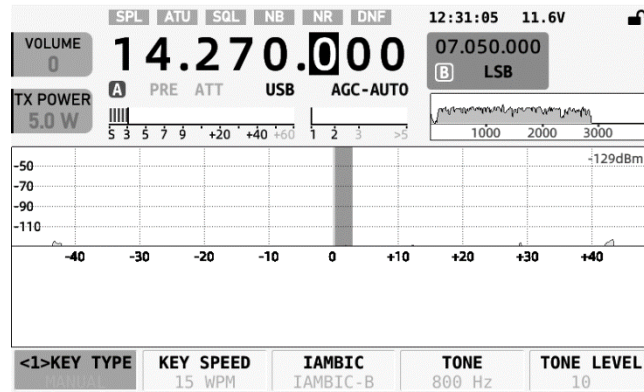

Menu <1> Definitions of functions are as follows:

KEY TYPE	KEY SPEED	IAMBIC	TONE	TONE LEVEL
Manual / automatic mode selection	Automatic key rate	Iambic mode	Side tone frequency	Side tone volume

Press the [KEY] key again to enter the menu on the second page of KEY items:

Menu <2> Definitions of functions are as follows:

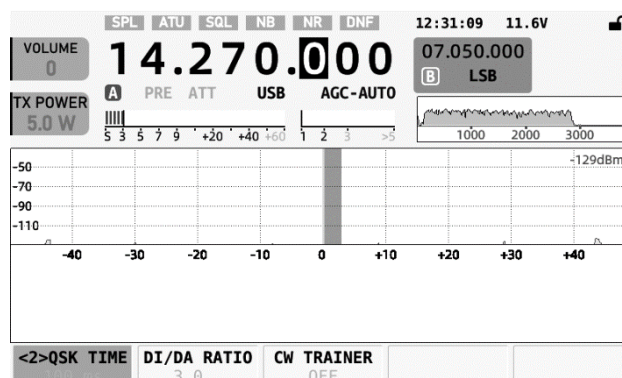

QSK TIME	DI/DA RATIO	CW TRAINER	---	---
QSK Time	Dot-and-dash ratio	Training mode switch	---	---

## MSG function setting operation

Short press [MSG] to enter the text preset menu on the first page of MSG, as shown below:

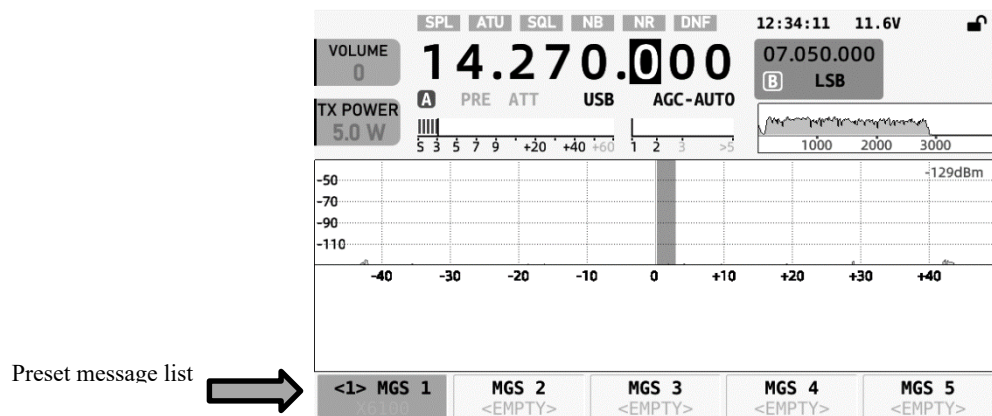

X6100 can pre-store 5 preset messages. These messages can be used for automatic transmission of CW, RTTY and BPSK. Click any MGS label to enter the editing interface, as shown below:

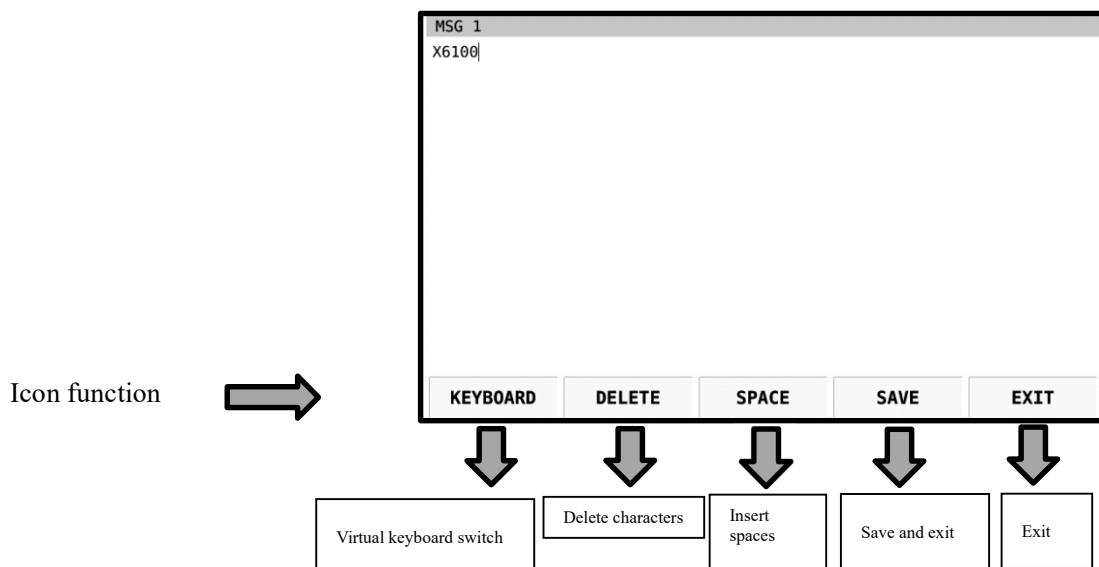

Open the virtual keyboard as shown below:

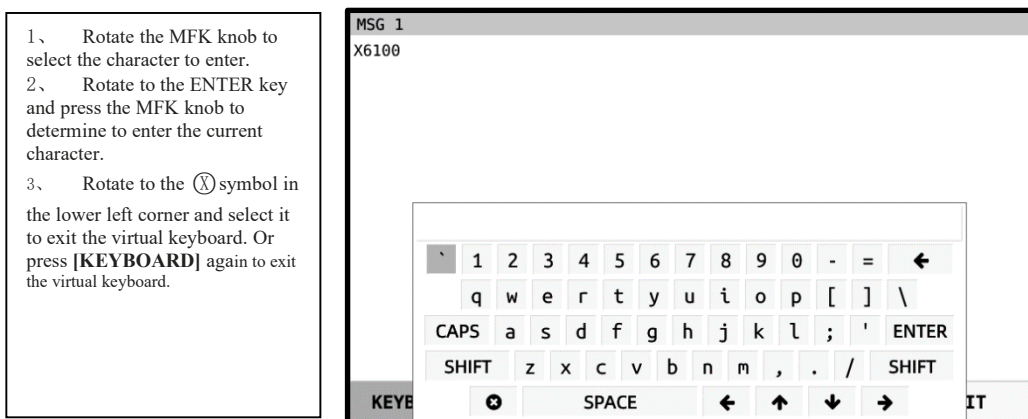

Press [MSG] again to enter the voice recording menu page on the second page of MSG options:

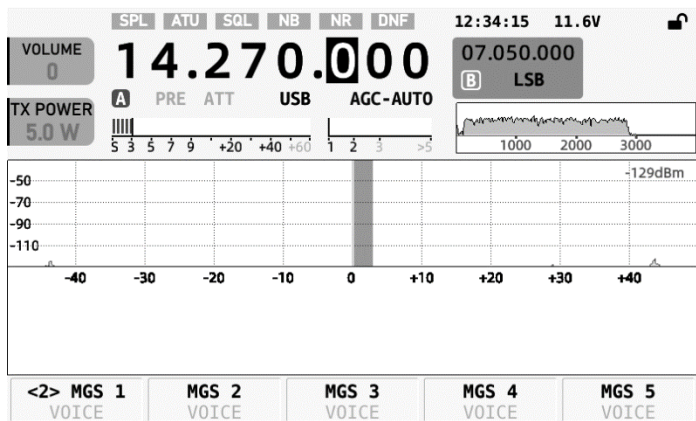

Preset recording list



X6100 can pre-store 5 voice messages. These messages can be used for automatic transmission of voice mode. Click any MGS label to enter the editing interface, as shown below:

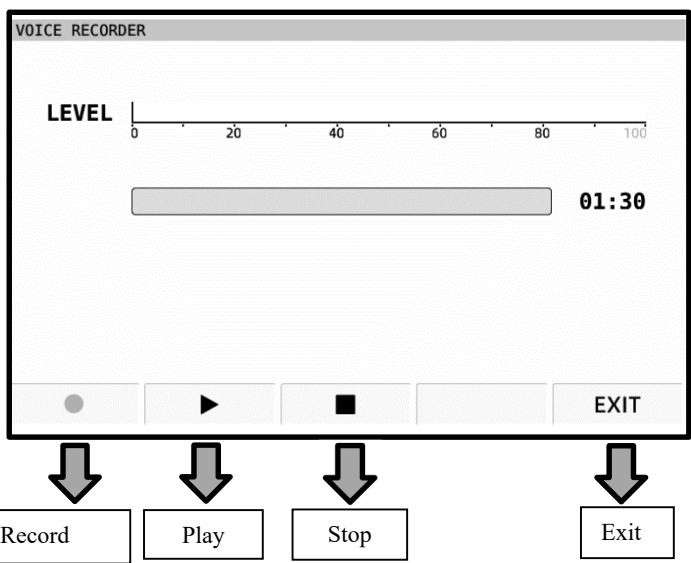

Icon function



**Recording operation method:**

- 1、 Pick up the hand microphone and keep it about 5~10cm away from the lips.
- 2、 Press the "Record" key and start speaking at a normal volume until the speech is finished.
- 3、 Press the "Stop" key to stop recording.
- 4、 Press the "Play" key to listen to the voice just recorded.
5. Press the "EXIT" key to exit the current page.

**Note:**

The maximum duration of each recording is 1 minute and 30 seconds.

## DFN function setting and operation

Short press [DFN] to enter the DFN option menu, as shown below:

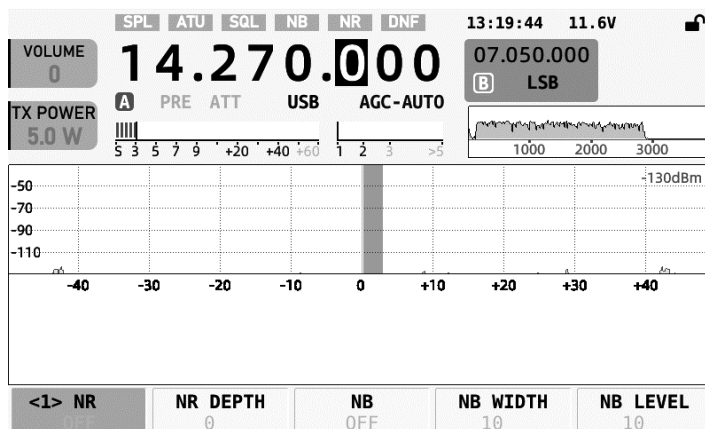

Menu <1> Definitions of functions are as follows:

NR	NR DEPTH	NB	NB WIDTH	NB LEVEL
Noise reduction switch	Noise reduction depth	Pulse blanking switch	Pulse width	Pulse depth

Press [DFN] again to enter the menu on the second page of DFN options:

Menu <2> Definitions of functions are as follows:

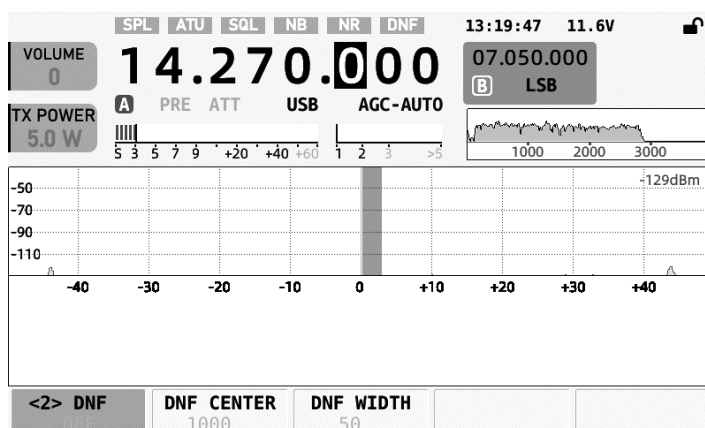

DNF	DNF CENTER	DNF WIDTH	---	---
Digital trap switch	Trap center frequency point	Trap bandwidth	---	---

## DFL function setting and operation

Short press [DFL] to enter the DFL option menu, as shown below:

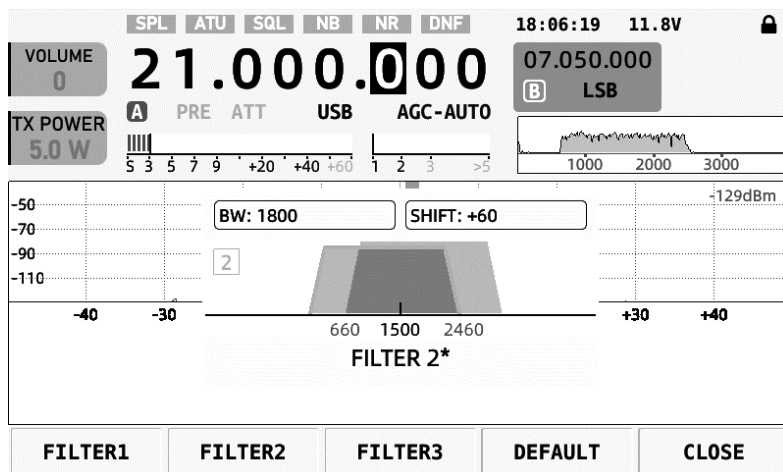

Operation methods:

1. Select any filter from FILTER1~3 to enter.
2. Short press the MFK knob to switch and select different edge-cut filters. The blue trapezoidal box is the high-cut filter (H-CUT), and the red trapezoidal box is the low-cut filter (L-CUT).
3. Rotate the MFK knob to adjust the parameters of the filter according to the actual use. After adjustment, the current filter parameters will be automatically stored in the corresponding filter label.
4. Short press [DEFAULT] to restore the filter parameters selected currently to the default parameters.
5. Short press [CLOSE] to exit the current interface.
6. As shown in the figure above, the start frequency and cut-off frequency of the filter can be adjusted respectively to set the filter. The overlapping region of the two schematic trapezoidal filter graphs is the actual action range of the filter. The details are as follows:

Filter composition diagram:

As shown in the figure on the right, the filter is acted by L-CUT and H-CUT together to form an effective filter bandwidth.

L-CUT controls the low boundary frequency and can effectively cut off the low frequency component;

H-CUT controls the high boundary frequency and can effectively cut off the high frequency component;

In daily use, it can be adjusted according to own habits to achieve the best listening effect.

\*Note: If the actual bandwidth of the filter is smaller than that of the useful signal, the useful signal will be completely cut off, resulting in no signal to be heard.

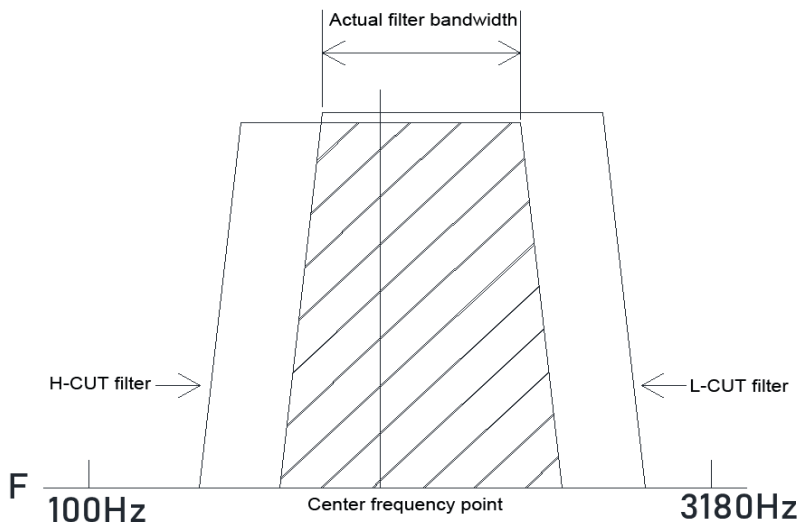

## Appendix 1

### Connection between X6100 and XPA125B (L4001 cable)

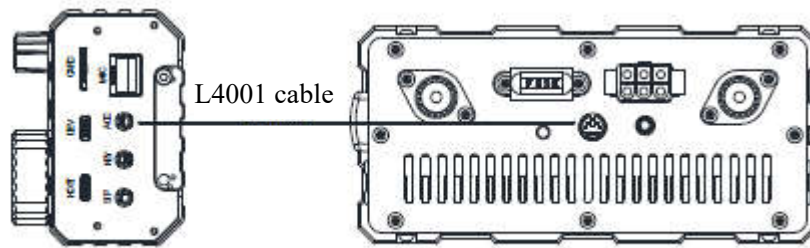

After the X6100 connects with XPA125B power amplifier and antenna tuner AIO through the L4001 cables, the output power can be expanded to 100W.

After connection, the X6100 can automatically control the wave band switching of XPA125B. Moreover, the ALC control will be built between two machines. When the X6100 output power exceeds the power limit of the XPA125B, the AACL control will automatically decrease the output power of the radio so that the output power of the XPA125B will be kept to be about 100W.

We suggest to set the output power of the X6100 to be  $\leq 2.5W$  to protect the amplifier equipment.

- XPA125B power amplifier and L4001 cable need to be separately ordered.

## Appendix 2

### Connection between X6100 and PC (Type-c)

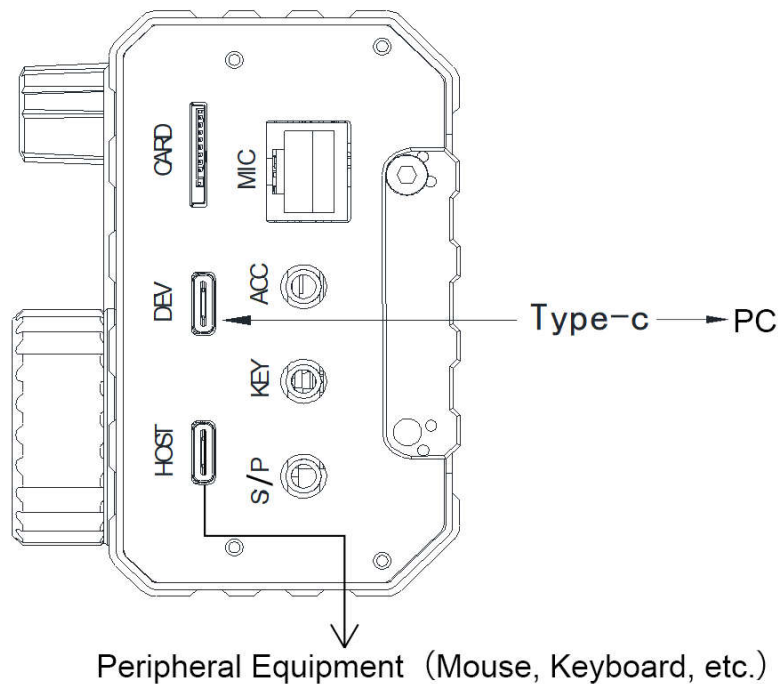

1. As shown in the figure above, connect the Type-C cable to the DEV port on the right side of the X6100.
2. The CH342 port driver needs to be installed.
3. Select the model "XIEGU X108G" on the data communication software (or Control Software) side to complete the connection.
4. Select the virtual sound card option through the control software to get sound input and output.

Note: If choose other rig that be compatible with CIV instructions, there may be incompatibility.

### Connect with N1MM to automatically transmit CW

The connection method is the same as above, and the port is also connected to the DEV port on the right side of the X6100. After configuring the settings of the N1MM terminal, the PC can be used to control the X6100 to send CW telegrams.

### External mouse 、 keyboard equipment

Connect the mouse, keyboard or other external input devices to the HOST interface on the right side of the X6100, and then you can operate the X6100 by the external mouse or keyboard.

## Parameter & specification

Frequency range: receiving: 0.5MHz~30MHz 50.00~54MHz

Transmitting: 1.8~2.0MHz 3.5~3.9MHz  
7.0~7.2MHz 10.1~10.15MHz  
14.0~14.35MHz 18.068~18.168MHz  
21.0~21.45MHz 24.89~24.99MHz  
28.0~29.7MHz 50.00~53.99MHz

Working mode: CW, AM, SSB, FM

Minimum stepping: 1Hz

Antenna impedance: 50  $\Omega$

Working temperature range: 0°C~+55°C

Frequency stability:  $\pm 1.5$ ppm within 10~30min after startup

@25°C: 1ppm/hour

Supply voltage: 9.0~15.0VDC, negative electrode grounding

Current consumption: receiving: 330mA@Max

transmitting: 3A@Max

Dimensions: 180\*86\*49mm (L\*W\*H) (not including protrusions)

Weight: about 880g (host only)

## Transmitter parameters

RF output power: 10W (SSB/CW/FM) @13.8VDC

2.5W (AM carrier wave) @13.8VDC

5W (SSB/CW/FM) @ battery

1.5W (AM carrier wave) @ battery

Spurious suppression: 1.8~29.6MHz:  $\geq 50$ dB

5(T54MHz): $\geq 60$ dB

Carrier suppression:  $\geq 50$ dB

Microphone impedance: 200~10k (600 $\Omega$  in general)

Receiver parameters

Circuit type: ZIF

Sideband suppression:  $\geq 50$ dB

MDS:-138dB

## Sensitivity:

Frequency band mode	SSB/CW	FM	AM
0.5~1.79999MHz	/	/	10uV
1.8~1.99999MHz	0.35uV	/	10uV
2.0~27.9999MHz	0.20uV	/	2uV
28.0~30.0MHz	0.20uV	0.22uV	2uV
50.0~54.0MHz	0.20uV	0.22uV	2uV



(PRE=050.0 ~ 54.0MHz N, ATT=off, NB=off, NR=off, SSB/CW/AM=10dB S/N, FM=12dB SINAD)

Audio output: 0.4W(8Ω, ≤10%THD)

Audio output impedance: 4~16Ω

### Antenna tuner

Tuning range of antenna tuner VSWR: 1:4.5

First tuning time: ≤15s

Memory load tuning: ≤0.2s

### Wireless network/Bluetooth

Wireless LAN standard: IEEE802.11b/g/n

Authentication and encryption: WEP (64/128bit)

WPA-PSK(TKIP)

WPA2-PSK(AES)

Frequency band: 2.4G

Bluetooth version: 4.0

- Above specifications are typical values and subject to change without prior notice.
- Working frequency range of transceiver varies from version of the equipment. Ask local dealer for details.

### Packing List

X6100 host: 1 pc.

Type-C cable: 1 pc.

Multifunction hand microphone: 1 pc.

Charger adapter: 1 pc.

Power cable: 1 pc.

Warranty card: 1 pc.

Manual: 1 pc.

Quality certificate: 1 pc.